

My
High School Years
1949-1955

By
Douglas
MacKenzie
Scribner

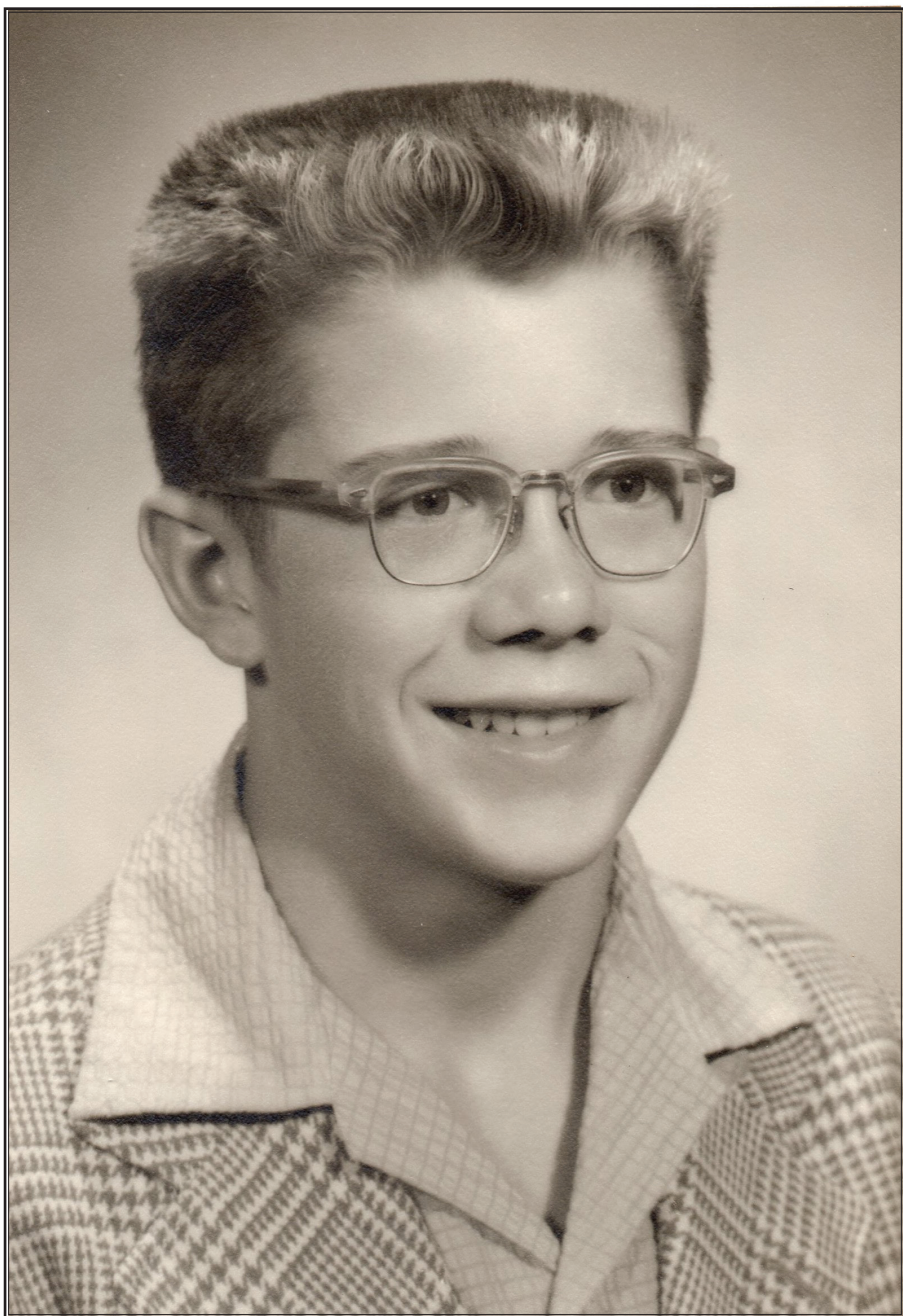

One of the last things that happened before I entered Junior High School was the death of my grandmother, Amelia Sophia Stumm Johnson, known as Emily. My grandfather Percy Townsend Johnson and his wife had moved to San Diego from Oakland while I was at the Alice Birney Elementary School, and would often visit us. Emily always had a very positive attitude. On one occasion she brought us two home baked pies and gave them to my older brothers to carry into the house. They each pranced in with a pie high over their head but one of them dropped his pie on the sidewalk upside down. Grandma just said, "Oh never mind, I'll just bake another one." She died on 30 January 1948, at the age of 67.



Emily Johnson with daughters Alice and Florence

The Horace Mann Junior High School was a very old building right next to the Alice Birney Elementary School. Of course Junior High was a totally new experience with six different classes, each with its own teacher. I struggled a bit at first with Math and Physical Education, but my scholarship grades came out above average in everything else. The two courses where I excelled were Glee Club (singing) and Mechanical Drawing. I did have a positive attitude so my citizenship grades were good.

7

Lasibner Max

Last Name _____ First Name _____ Middle Name _____ Grade _____

Report for Quarter Ending _____ JUN 16 1950 _____ 19 _____ ORIGINAL

Period	Grade	SUBJECT	Scholarship	Citizenship	TEACHER	REMARKS
1	7	Math	C	B	Lozanger	
2	7	Glee	A	A	L. Woods	nice work.
3	7	P. Ed	C	A	Fansler	
4	7	M. Draw	A	A	Miller	
5	7	S. Sci	B	B	Holt	Very nice.
6	7	Eng	B	A	Mayer	

SCHOLARSHIP

This concerns itself with the student's progress in gaining subject information, acquiring or improving some special skills and abilities, and growth in desirable attitudes and appreciation.

Lozanger

Teacher

Parent's Signature

CITIZENSHIP

Co-operation—Working well and willingly with others. Making good use of one's time. Exhibiting a proper attitude toward all regulations.

Reliability—Being trustworthy at all times. Being prompt, industrious, and dependable.

Courtesy—Displaying thoughtfulness in speech and actions. Showing respect for the rights, feeling, and property of others.

MARKS A—Superior B—Above Average C—Satisfactory D—Below Average F—Inferior work—No Credit.

Mechanical Drawing became a passion, possibly because my father loved it.

An example of the concepts learned in the Mechanical Drawing Class is what they called "Isometric Drawing" at an angle of 30 degrees.

ISOMETRIC

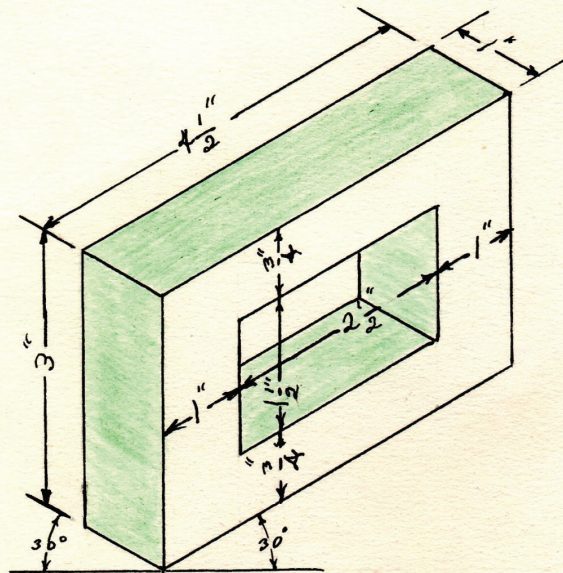

SCRIBNER, MAC
MAY 3, 1951

8TH
V_{PER}

HORACE

These drawings require that you consider the angle at which you observe the item and draw that perspective with pen and ink.

DRAWINGS 30°

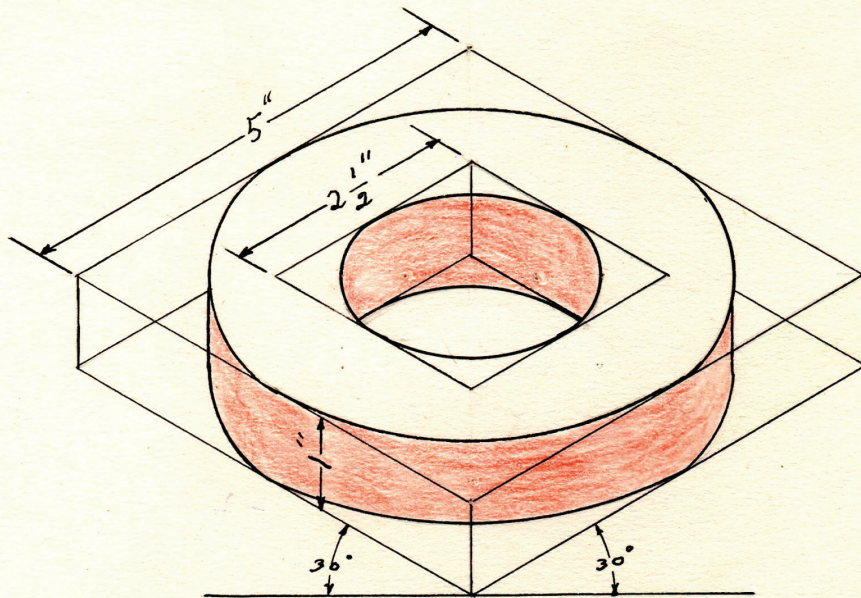

MANN

SCALE $\frac{1}{2}'' = 1''$
PLATE X

MECHANICAL
DRAWING

4

During the years at Horace Mann Junior High, I continued my participation in service activities and also began to take lessons in horse-back riding. The stables were in Mission Valley, near our home, and always cumulated in competitive demonstrations of what had been learned. I got third place in the competition.

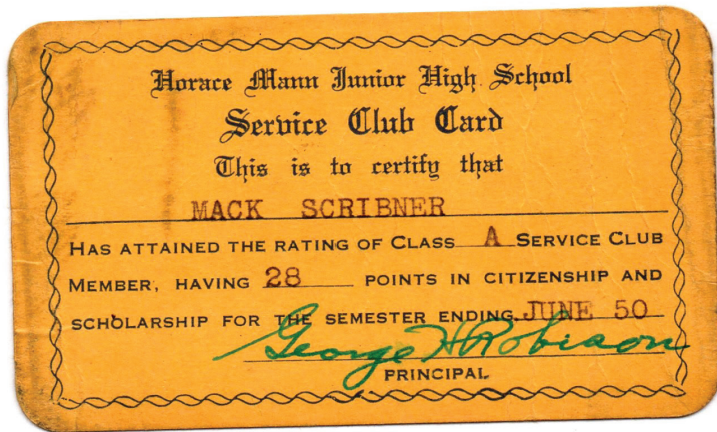
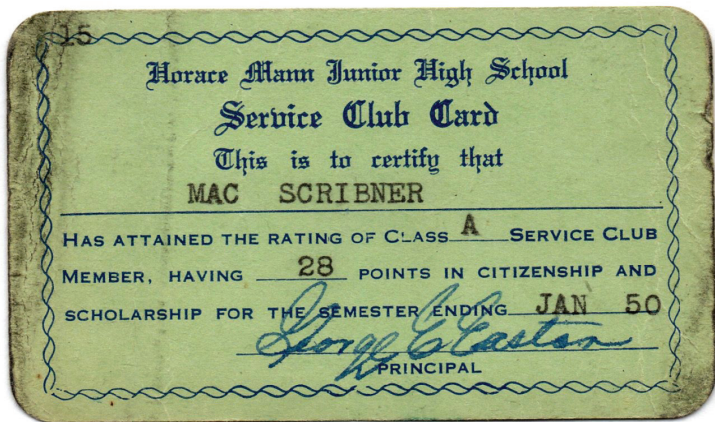

During the summers of my Junior High years, the family continued to take wonderful vacation trips to beautiful places around California.



Trinity Alps Cabin



Devils Postpile Park



Grandpa Johnson



Grandpa Scribner

The other big activity which started in Junior High School was my involvement with the Boy Scouts of America. Having completed Cub Scouts while in Elementary School, my friend Harry Schenck and I enrolled in Boy Scout Troop 33, sponsored by a local Christian Church. We progressed rapidly through the ranks of Tenderfoot, Second Class and First Class so we could start working on Merit Badges. One of the badges we chose was "Woodcarving" so, with the help of my father, we created a five foot tall Totem Pole. It was completed in 1950 and got the attention of the local newspapers.

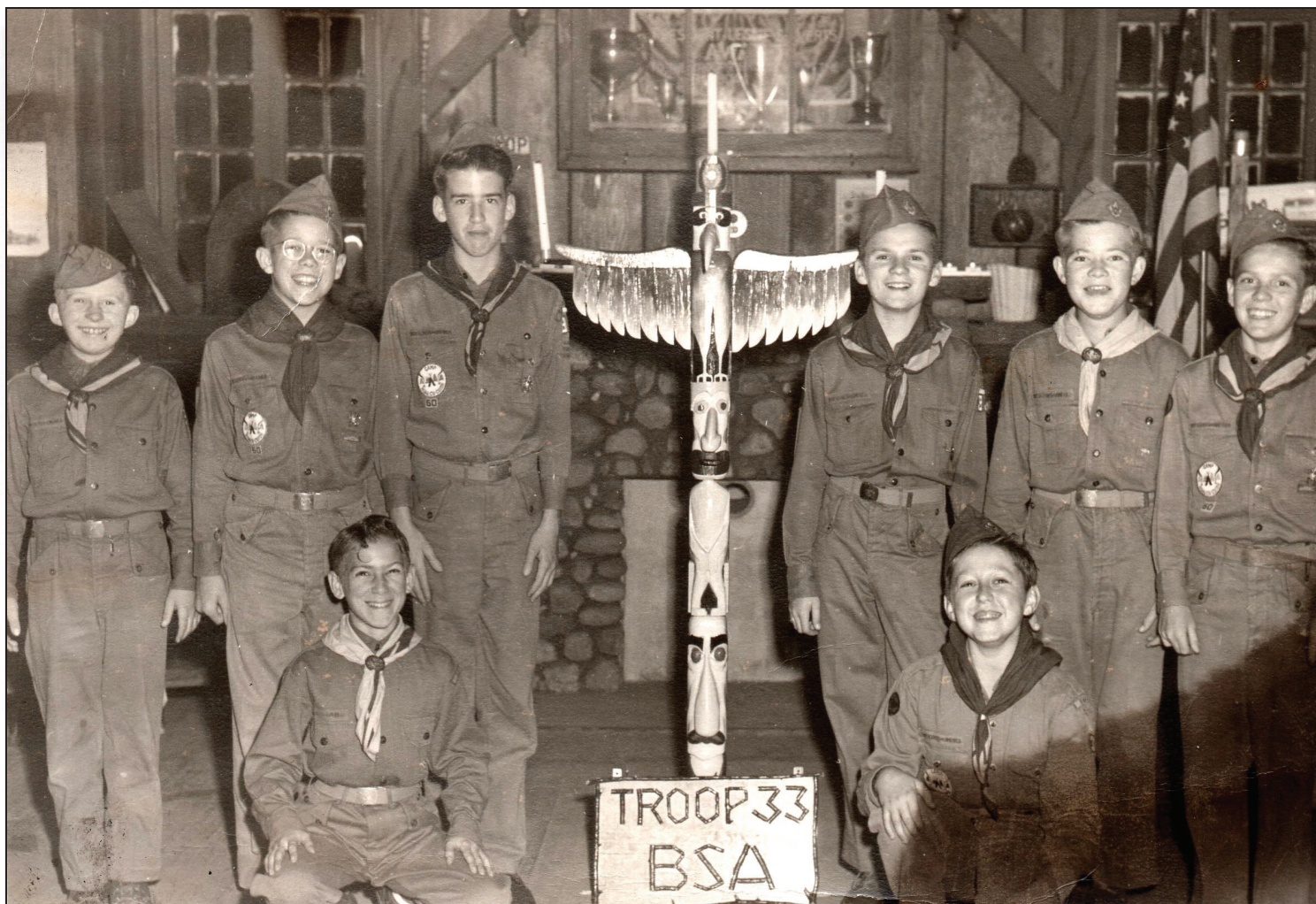

Mac Scribner
on
the left

Harry Schenck
on
the right

Being an optometrist, my father realized that I was near-sighted and needed to wear glasses. Once I got used to them, my studies improved. By the end of the eighth grade my grades in P.E. and Math had improved to an A level. However it was also the end of an era. The Horace Mann School was so old it was declared unsafe and had to be closed. Based on where students lived they had to transfer to a different Junior High School for the 9th grade. Harry went to one school and I went to another. For me it was the Roosevelt Junior High School near Balboa Park.

Scribner, Mac		Lg				
Last Name		Grade				
Report for Quarter Ending		1952				
Jan 25		ORIGINAL				
Period	Grade	SUBJECT	Scholar-ship	Citizen-ship	TEACHER	REMARKS
1	9	Spanish	B	A	E. J. ...	High "B"
2	9	Soc Studies	B	B	W. J. Nelson	
3	9	Grec Club	B	A	C. Wright	
4	9	English	B	B	J. Hill	
5	9	PE	A	B	J. H. Bay	
6	9	ALgebra	A	A	D. ...	Weak
<p>SCHOLARSHIP</p> <p>This concerns itself with the student's progress in gaining subject information, acquiring or improving some special skills and abilities, and growth in desirable attitudes and appreciation.</p>		<p><i>W. J. Nelson</i></p> <p>Teacher</p>		<p>CITIZENSHIP</p> <p>Co-operation—Working well and willingly with others. Making good use of one's time. Exhibiting a proper attitude toward all regulations. Reliability—Being trustworthy at all times. Being prompt, industrious, and dependable. Courtesy—Displaying thoughtfulness in speech and actions. Showing respect for the rights, feeling, and property of others.</p>		
<p>MARKS: A—Superior B—Above Average C—Satisfactory D—Below Average F—Inferior work—No Credit.</p>		<p><i>Mac Scribner</i></p> <p>Parent's Signature</p>				

Now on to -

Roosevelt Junior High School

Harry Schenck's new friend from Wilson Junior High was Jerry Lawrence who joined us in our pursuit of the Eagle Scout award. Here we were working on the "Cycling" merit badge.



Meanwhile I placed my school efforts on academics and became part of the "Sombrero Society" with its focus on good citizenship.



*Finally, graduation from Roosevelt Junior High School in June 1952
with two of my closest friends Paul Houghtaling and Fred Kerth.*

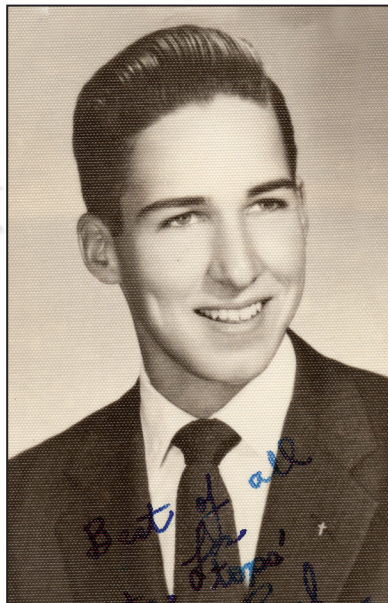

Paul

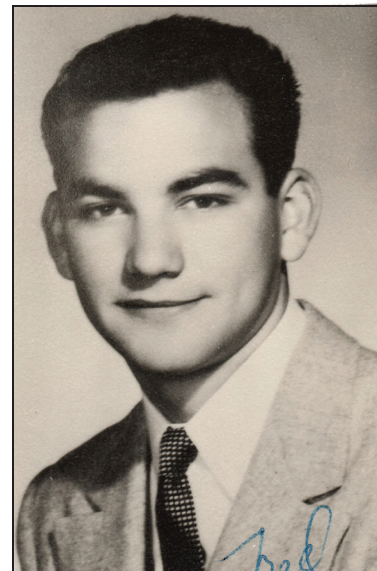

Fred

San Diego City Schools
Certificate of Promotion
Junior High Schools

The Principal and Faculty of the
Roosevelt Junior High School

Certify that DOUGLAS MacKENZIE SCRIBNER
has successfully completed the prescribed requirements and is hereby recommended
for admission to any Senior High School

Ene P. Larsen
Principal

Dated this 11TH day of JUNE, 1952

In the Fall of 1952 I enrolled in San Diego High School which was known as the "Old Gray Castle." I was only fourteen years old, which made me about the youngest student in my class. At that time my dad was elected as President of the local Lions Service Club and my mom was raising Steve and frequently gathering the family together.

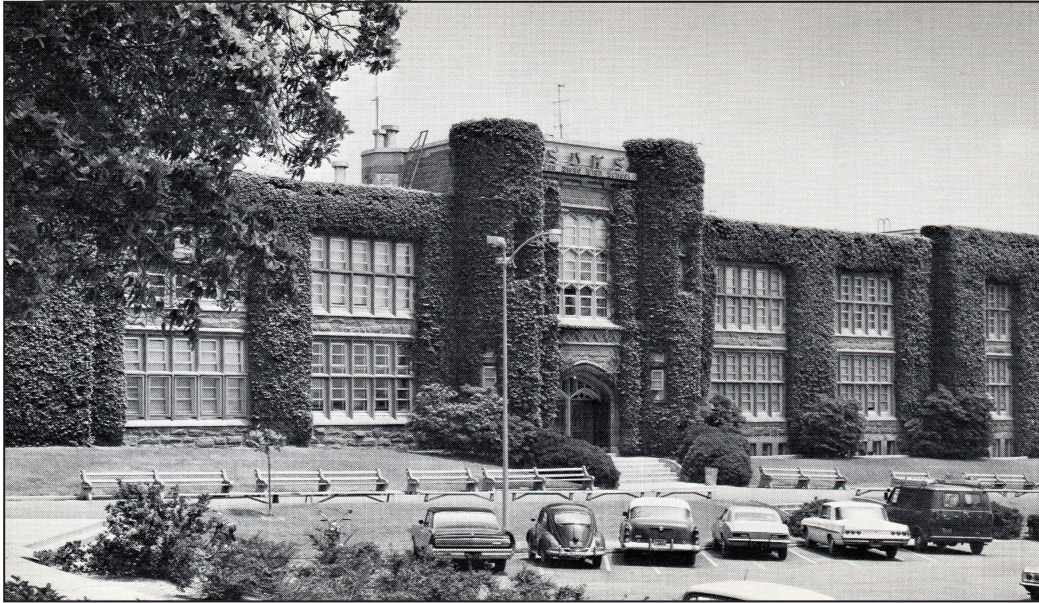

San
Diego
High
School

Gordon Scribner Named Hillcrest Lions' President

Ratification of a panel of officers previously placed in nomination and the induction of a new member, Russell Crofoot, owner of the Lincoln Ambulance Service, highlighted this week's meeting of the Hillcrest Lions Club.

Elected unanimously, the following officers will serve the current fiscal year:

President, Dr. Gordon Scribner; first vice-president, Jerry Awes; second vice-president, John A. Lasher; third vice-president, W. W. Wilson; secretary, Bob Burgert;



Dave &
Marion



Percy, Irvin, Ella, Alice
Gordon, dog & Steve

1953 was the year that the National Scout Jamboree was held at Irvine Ranch in Southern California which made it affordable for Harry & me to go. It was full of exciting activities. Harry was our senior leader.



Packing to go!

The actual Jamboree, held in the summer of 1953, was a week of camping, hiking and other fun activities to celebrate scouting.



Horry and another leader

Another passion of mine was the beach! I loved swimming in the ocean and body-surfing (without a surfboard). Even skin diving for abalone was an exciting activity. We lived close so I rode my bicycle from our house to Mission Beach and sometimes even La Jolla Cove.

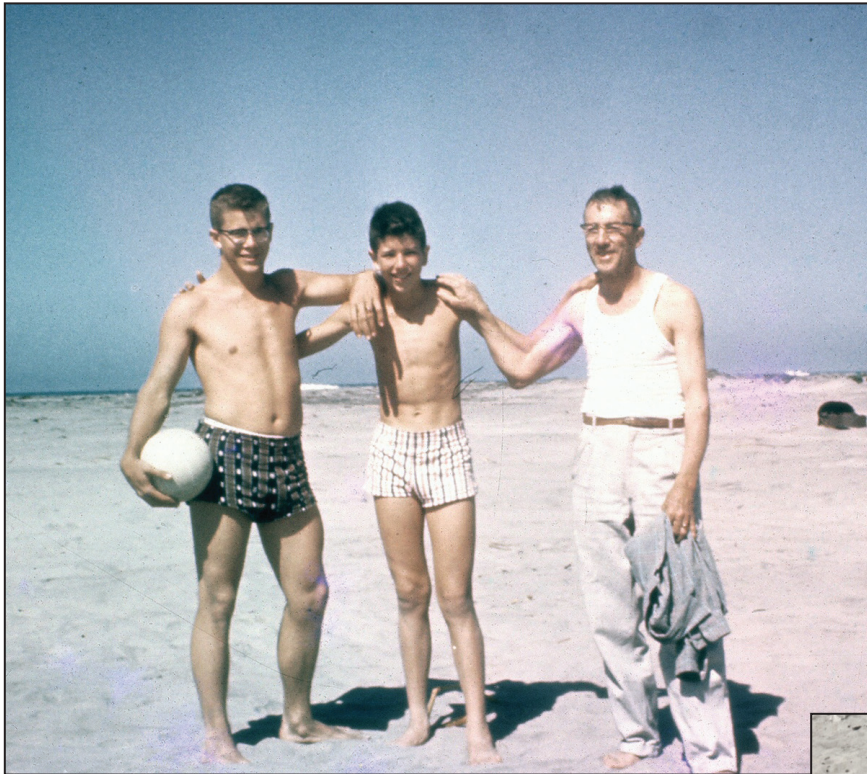

Mac, Steve and Gordon at Pacific Beach.

NAME MAC SCRIBNER
 SCOUTING UNIT TROOP 33
 HAS MET THE REQUIREMENTS
 FOR THE MERIT BADGE IN
SWIMMING - LIFE SAVING
 DATE JULY 31, 1952
BALBOA COUNCIL
R. Parker
 ADVANCEMENT COMMITTEE
P. Henry
 SCOUT EXECUTIVE

Swimming and Life Saving Merit Badges.

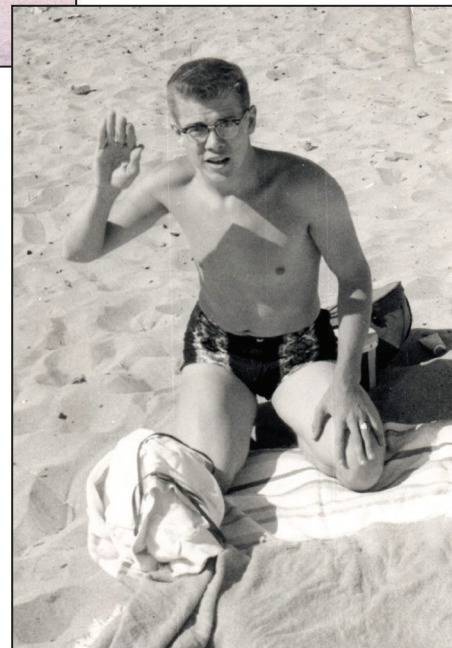

Enjoying the Sand

In November 1953 the day finally came when I received my Eagle Scout Award. I was just 15 years old but it had been a long, hard effort and I was very happy.

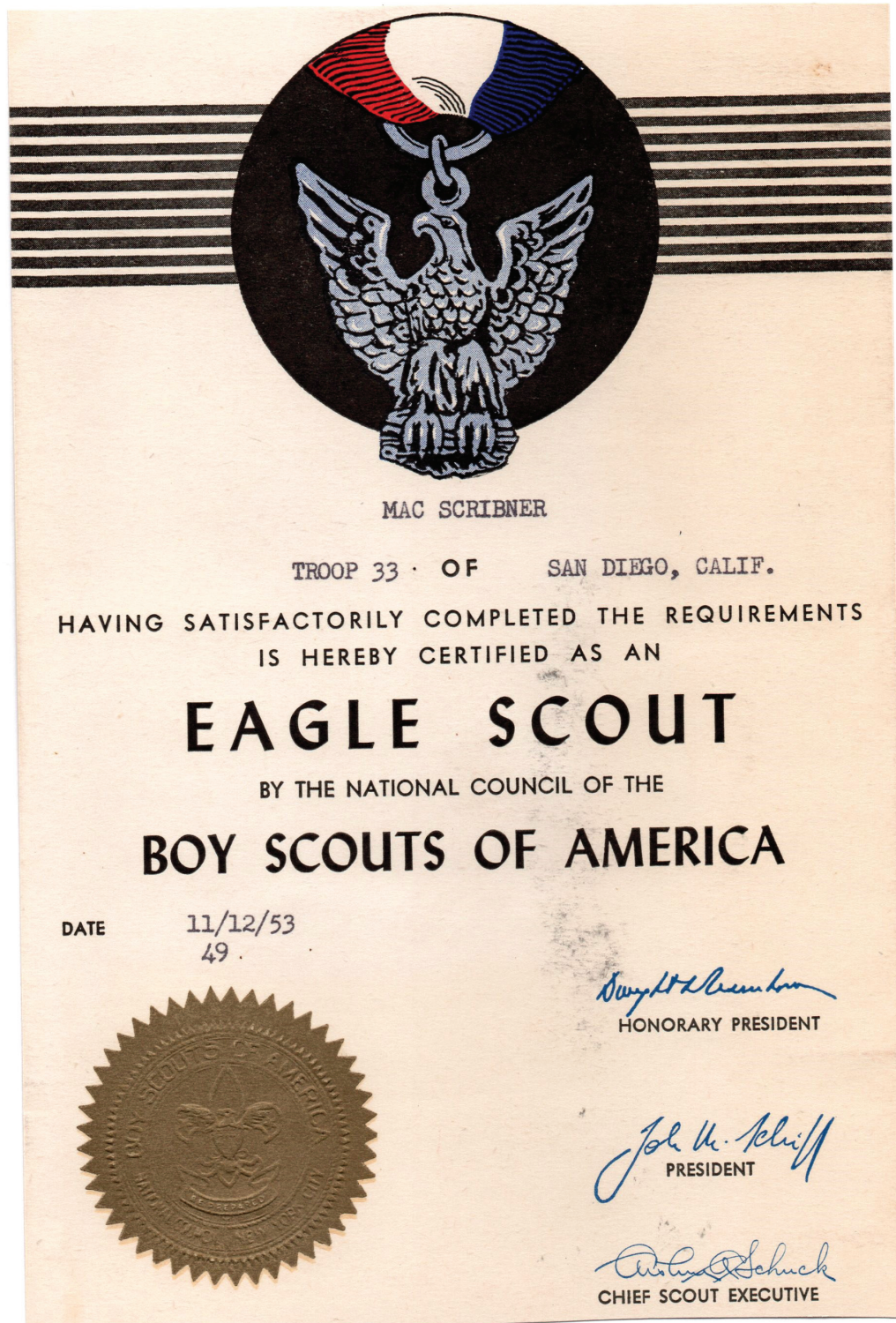

Then, the following February, Harry and I, together with a few others, were given special recognition by the San Diego Mayor and his City Council. We each sat by a councilman and, perhaps because it was my birthday, I was selected by Mayor Butler to be honored as the “San Diego Mayor of the Day.”



IN MAYOR'S CHAIR—Eagle Scout Max Schribner, 16, of 1433 Golden Gate Dr., takes the gavel from Mayor Butler to preside at the City Council session today as Scouts took over local government. This is Boy Scout Week.—Tribune Photo

Becoming sixteen half way through my Junior Year of High School was a turning point in my life. I was able to get a driver's license! Since I had been delivering newspapers for a couple of years and saving my money, I decided to buy my own car. The car I found was a 1938 Chevy coupe which was manufactured the same year I was born. It cost \$100. I started driving it to school and even thought about going on a date. At least I was older than freshman girls but nothing seemed to work out for any dates. So, in addition to my academic studies, I decided to join a Service Club. I was active in the San Diego High School Choir under the direction of E. Harrison Maxwell but I also joined the "Key Club" which was sponsored by the Kiwanis Service Club.



Then, in Los Angeles on 21 August 1954, my brother Ken married Muriel Winnifed Patterson whom we all loved and called Pat.

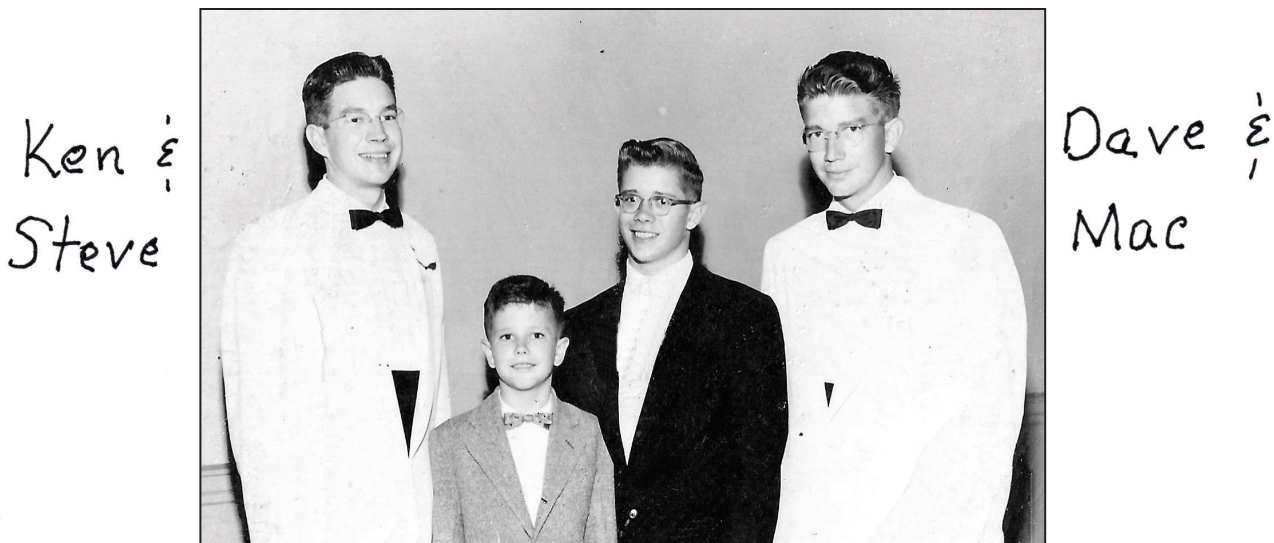

In my Senior Year of High School I wanted to be more social. So I ran for a school office and was elected as Senior Class Treasurer. This helped me develop friendships with several girls and fellows.



Donna



Gwen

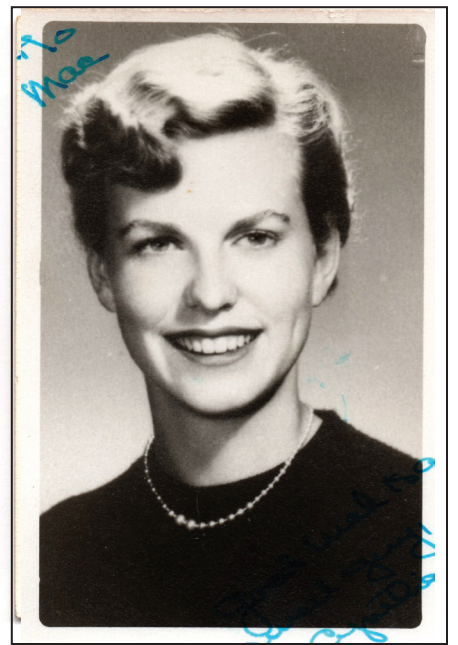

Cynthia

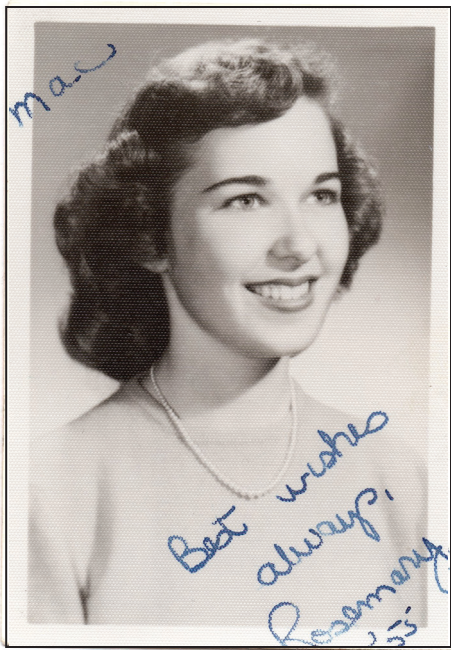

Rosemary



Karen



Barbara

Sometimes these friendships turned into dating opportunities. Here Mike Ruplinger and I had a double date with Barbara Willett and Karen Hastings. It was lovely but there were no lasting commitments.

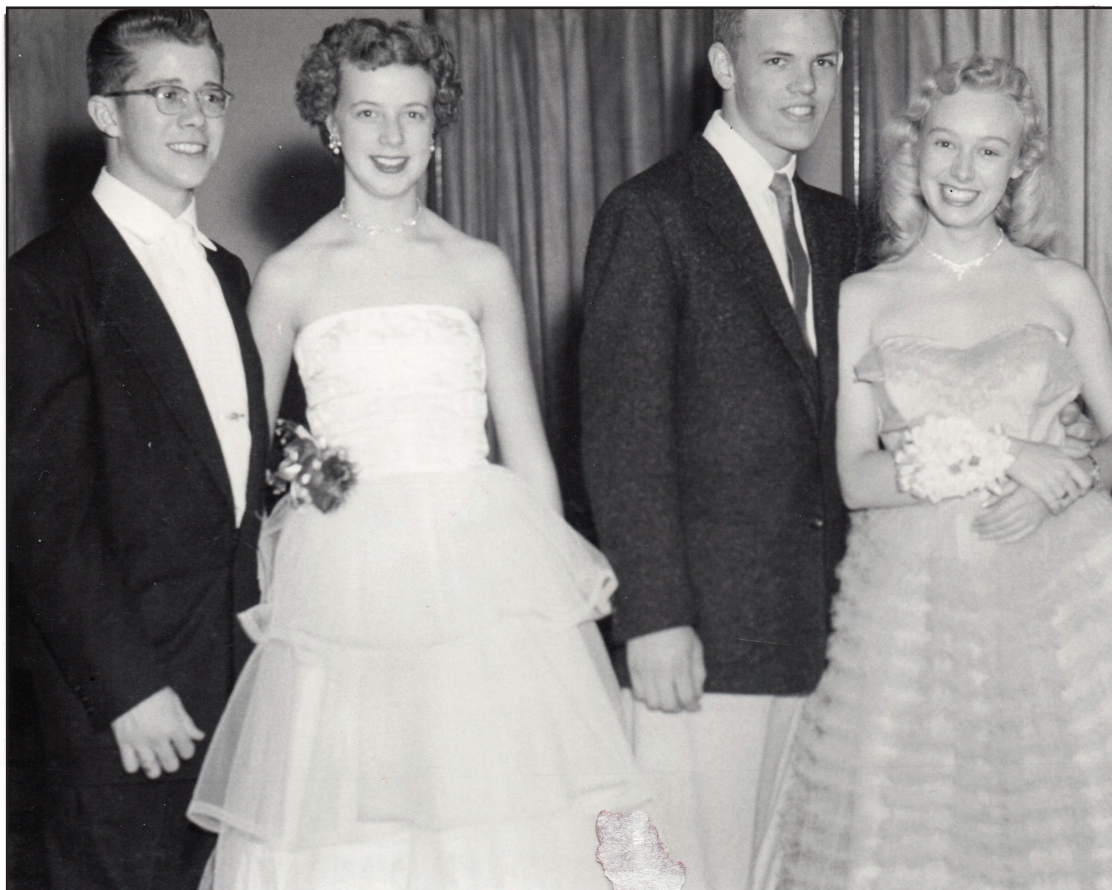

For me, the 12th grade was also a time of spiritual awakening. I had gone occasionally to the North Park Congregational Church with my mother but I had very little knowledge about Christianity. However, my High School Choir sang some religious songs. One day we were performing at an amphitheater in Balboa Park and sang "Jerusalem – The Holy City." I had an overwhelming feeling that Jesus Christ was real and that his birth, life, ministry, death and resurrection were the most significant events of all time. When I told him, Harry agreed so he and I started attending the Congregational Church Youth Group.

Two of the girls in the Congregational Church Youth Group were Alice Lantz and Jude Henke. Alice and I began dating though she refused to call me Mac. Instead she insisted in calling me Doug. As a result I entered all of my college application forms as Doug with the decision I would go by my real name during my college years. Harry also started dating Judy on a regular basis. Harry and Judy later married but Alice and I did not.

Alice



Judy



Alice and Doug

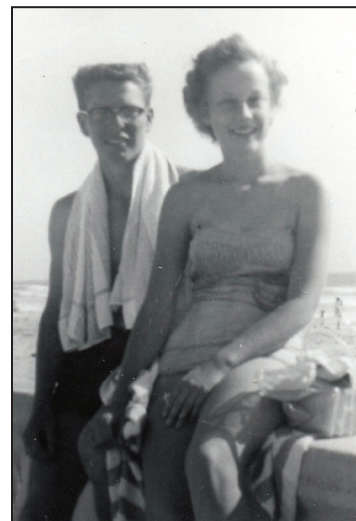

Harry and Judy

It was clear that Math and Physics were my strongest academics in Senior High School. I took courses in Advanced Algebra, Geometry and Trigonometry. As a result I received "Honor Roll Recognition" along with some of my classmates From the University of Oklahoma. This helped me with my college applications, but it was not the whole answer.

SDHS Rates High; Math Brains Named

Reports received from the University of Oklahoma indicate for the second straight time that San Diego high school mathematics majors in Mr. Horace Kennedy's college preparatory math classes can hold their own in national competition.

The twenty students who hit the "honors Jack Pot" in this second competition were Richard Chan, Kenneth Chew, Ned Dryer, Stu Gildred, George Hayashi, John Hom, Gordy Jones, Richard Kahle, Jerry Lohmann, Rowena Naidl, Tom Pehka, Willis Pflugh, Robert Rens, Mac Scribner, Johanne Steinmetz, John Stephens, Bob Stewart, Richard Witherow, Bill Woolfolk and Jerry Wright.

SDHS Class Wins Mathematics Honor

San Diego High School is one of nine high schools in the nation selected by the University of Oklahoma for a place on its high school mathematics honor roll, Ralph Dailard, San Diego schools superintendent, said yesterday.

The honor was based on the excellent performance of students in teacher Horace Kennedy's mathematics class at the high school, Dailard said.

Twenty members of Kennedy's class received individual honors for consistency in solving difficult problems.

Richard Witherow, Will Woolfolk and Jerry Wright.

Stanford University also placed equal value on my extra-curricular activities and awards. Thus on 14 April 1955 I received a letter from the Stanford Director of Admissions that I could attend the university the following Fall. Mom and Dad were very excited with the news but the big issue then was how to pay for it.

Alice and
Gordon



As the time for graduation drew near I contracted a case of mumps. A Senior Prom was no longer possible for me even though Alice had purchased a new dress for the occasion. As a class officer I was supposed to lead the graduation procession in the football stadium but had not been to any rehearsals. Still, I got the doctors release so I could make it to the ceremony. I led the 500 graduates down the field and somehow we made it to our seats for the graduation program.

San Diego High School

San Diego, California

Be it known that

Douglas MacKenzie Scribner

having completed a course of study prescribed for graduation from the San Diego High School is granted this diploma.

Given at San Diego, California, this seventeenth day of June, nineteen hundred and fifty-five.

Lawrence C. Coe, Jr.

Principal

Kenneth R. Rearwin

President of the Board of Education

Ralph Siskind

Superintendent of Schools

One important event that happened in July 1955 was the passing of my grandmother Scribner. Her maiden name was Isabella Livingstone MacKenzie, which is where I got my middle name. However she went by the name Ella. Having been born in Dingwall, Northern Scotland she immigrated to Oshkosh, Wisconsin with her family when she was only ten years old. This is where Ella grew up and married Irvin Aldridge Scribner in 1899. Their son Gordon Raymond Scribner, born in 1900, was her only child. Irvin, Ella and Gordon moved from Wisconsin to San Diego, California in 1909. Here she lived until she died at the age of 77 years.



Gordon and Ella

Irvin and Ella

"Nay Bad ah toll, ah toll"

The last challenge before college was raising the money needed to pay tuition, room and board. In 1955 the tuition was \$750 dollars per year which seemed like a lot of money back then. I needed a job! Remembering the day I was honored as "Mayor for a Day," I recalled that I sat next to a sponsor who owned a Civil Engineering Company. That day Mr. Freeman had said, "If you ever need a job, come see me." So, I did! His office was on the top floor of a San Diego high rise building. He came through on his promise, so I got to work on one of his survey crews for the summer. Now I was ready for Stanford.

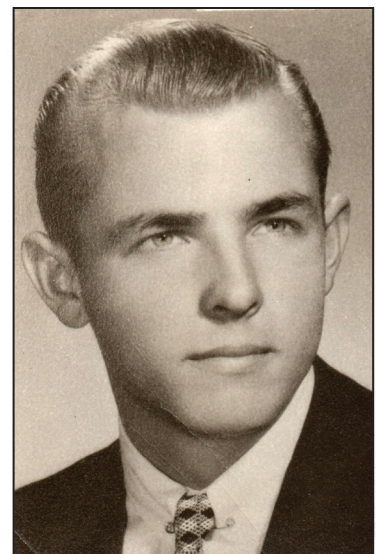
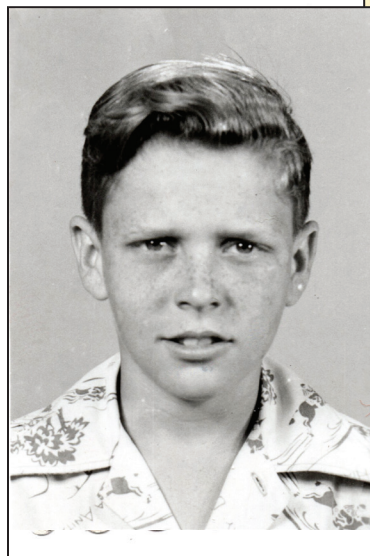
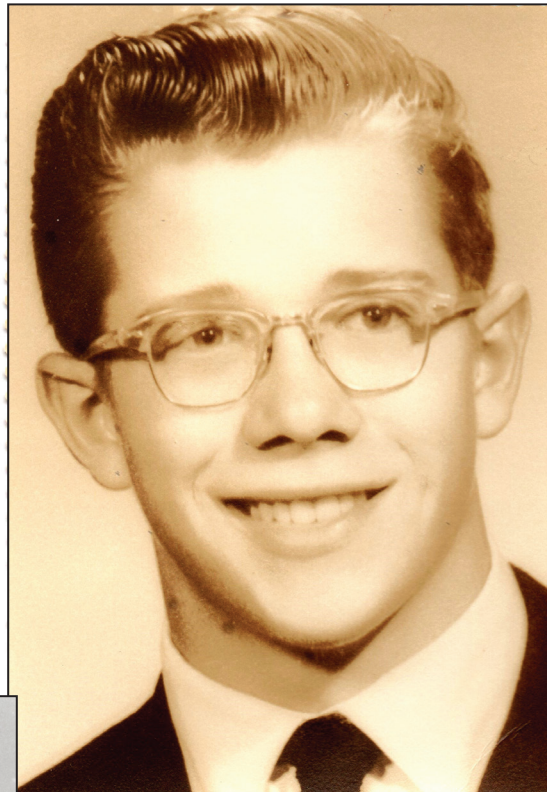

Doug and
Friends

Harry
Schenck

Jerry
Lewis